

6MBP75VDA060-50

IGBT Modules

IGBT MODULE (V series)

600V / 75A / IPM

■ Features

- Temperature protection provided by directly detecting the junction temperature of the IGBTs
- Low power loss and soft switching
- High performance and high reliability IGBT with overheating protection
- Higher reliability because of a big decrease in number of parts in built-in control circuit

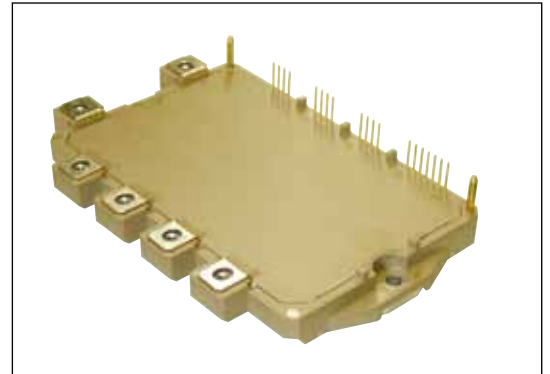

■ Maximum Ratings and Characteristics

● Absolute Maximum Ratings (T_c=25°C, V_{cc}=15V unless otherwise specified)

Items		Symbol	Min.	Max.	Units	
Collector-Emitter Voltage (*1)		V _{CEs}	0	600	V	
Short Circuit Voltage		V _{sc}	200	400	V	
Inverter	Collector Current	DC	I _c	-	75	A
		1ms	I _{cp}	-	150	A
		Duty=77.1% (*2)	-I _c	-	75	A
Collector Power Dissipation		1 device (*3)	P _c	-	250	W
Brake	Collector Current	DC	I _c	-	-	A
		1ms	I _{cp}	-	-	A
	Forward Current of Diode		I _F	-	-	A
	Collector Power Dissipation		1 device (*3)	P _c	-	-
Supply Voltage of Pre-Driver (*4)		V _{cc}	-0.5	20	V	
Input Signal Voltage (*5)		V _{in}	-0.5	V _{cc} +0.5	V	
Alarm Signal Voltage (*6)		V _{ALM}	-0.5	V _{cc}	V	
Alarm Signal Current (*7)		I _{ALM}	-	20	mA	
Junction Temperature		T _j	-	150	°C	
Operating Case Temperature		T _{opr}	-20	110	°C	
Storage Temperature		T _{stg}	-40	125	°C	
Solder Temperature (*8)		T _{sol}	-	260	°C	
Isolating Voltage (*9)		V _{iso}	-	AC2500	V _{rms}	
Screw Torque	Terminal (M4)	-	-	1.7	Nm	
	Mounting (M4)	-	-	-	-	

Note *1: V_{CEs} shall be applied to the input voltage between terminal P-(U,V, W) and (U,V, W, B)-N.

Note *2: Duty=125°C/R_{th(j-c)}D / (I_F×V_F Max.)×100

Note *3: P_c=125°C/R_{th(j-c)}Q (Inverter & Brake)

Note *4: V_{cc} shall be applied to the input voltage between terminal No.4 and 1, 8 and 5, 12 and 9, 14 and 13.

Note *5: V_{in} shall be applied to the input voltage between terminal No.3 and 1, 7 and 5, 11 and 9, 15~18 and 13.

Note *6: V_{ALM} shall be applied to the voltage between terminal No.2 and 1, 6 and 5, 10 and 9, 19 and 13.

Note *7: I_{ALM} shall be applied to the input current to terminal No.2,6,10 and 19.

Note *8: Immersion time 10±1sec. 1time.

Note *9: Terminal to base, 50/60Hz sine wave 1min. All terminals should be connected together during the test.

● Electrical Characteristics ($T_J=25^\circ\text{C}$, $V_{CC}=15\text{V}$ unless otherwise specified)

Items	Symbol	Conditions	Min.	Typ.	Max.	Units		
Inverter	Collector Current at off signal input	I_{CES}	$V_{CE}=600\text{V}$	-	-	1.0	mA	
	Collector-Emitter saturation voltage	$V_{CE(sat)}$	$I_C=75\text{A}$	Terminal	-	-	2.10	V
				Chip	-	1.40	-	V
	Forward voltage of FWD	V_F	$I_F=75\text{A}$	Terminal	-	-	2.40	V
Chip				-	1.80	-	V	
Brake	Collector Current at off signal input	I_{CES}	-	-	-	mA		
	Collector-Emitter saturation voltage	$V_{CE(sat)}$	-	-	-	V		
			-	-	-	V		
Forward voltage of FWD	V_F	-	-	-	V			
		-	-	-	V			
Switching time	t_{on}	$V_{DC}=300\text{V}$, $T_J=125^\circ\text{C}$, $I_C=75\text{A}$	1.1	-	-	μs		
	t_{off}		-	-	2.1	μs		
	t_{rr}	$V_{DC}=300\text{V}$, $I_C=75\text{A}$	-	-	0.3	μs		
Supply current of P-side pre-driver (per one unit)	I_{cop}	Switching Frequency= 0-15kHz $T_C=-20\sim 110^\circ\text{C}$	-	-	13	mA		
Supply current of N-side pre-driver	I_{con}		-	-	42	mA		
Input signal threshold voltage	$V_{in(th)(on)}$	V_{in-GND}	ON	1.2	1.4	1.6	V	
	$V_{in(th)(off)}$		OFF	1.5	1.7	1.9	V	
Over Current Protection Level	Inverter	I_{OC}	$T_J=125^\circ\text{C}$	113	-	-	A	
				Brake	-	-	-	A
Over Current Protection Delay time	t_{dOC}	$T_J=125^\circ\text{C}$	-	5	-	μs		
Short Circuit Protection Delay time	t_{sc}	$T_J=125^\circ\text{C}$	-	2	3	μs		
IGBT Chips Over Heating Protection Temperature Level	$T_{J(OH)}$	Surface of IGBT Chips	150	-	-	$^\circ\text{C}$		
Over Heating Protection Hysteresis	T_{JH}		-	20	-	$^\circ\text{C}$		
Under Voltage Protection Level	V_{UV}		11.0	-	12.5	V		
Under Voltage Protection Hysteresis	V_H		0.2	0.5	-	V		
Alarm Signal Hold Time	$t_{ALM(OC)}$	ALM-GND $T_C=-20\sim 110^\circ\text{C}$	$V_{CC} \geq 10\text{V}$	1.0	2.0	2.4	ms	
	$t_{ALM(UV)}$			2.5	4.0	4.9	ms	
	$t_{ALM(TJOH)}$			5.0	8.0	11.0	ms	
Resistance for current limit	R_{ALM}		960	1265	1570	Ω		

● Thermal Characteristics ($T_c = 25^\circ\text{C}$)

Items		Symbol	Min.	Typ.	Max.	Units	
Junction to Case Thermal Resistance (*10)	Inverter	IGBT	$R_{th(j-c)Q}$	-	-	0.50	$^\circ\text{C/W}$
		FWD	$R_{th(j-c)D}$	-	-	0.90	$^\circ\text{C/W}$
	Brake	IGBT	$R_{th(j-c)Q}$	-	-	-	$^\circ\text{C/W}$
		FWD	$R_{th(j-c)D}$	-	-	-	$^\circ\text{C/W}$
Case to Fin Thermal Resistance with Compound		$R_{th(c-f)}$	-	0.05	-	$^\circ\text{C/W}$	

Note *10: For 1device, the measurement point of the case is just under the chip.

● Noise Immunity ($V_{DC}=300\text{V}$, $V_{CC}=15\text{V}$)

Items	Conditions	Min.	Typ.	Max.	Units
Common mode rectangular noise	Pulse width $1\mu\text{s}$, polarity \pm , 10 minute Judge : no over-current, no miss operating	± 2.0	-	-	kV

● Recommended Operating Conditions

Items	Symbol	Min.	Typ.	Max.	Units
DC Bus Voltage	V_{DC}	-	-	400	V
Power Supply Voltage of Pre-Driver	V_{CC}	13.5	15.0	16.5	V
Switching frequency of IPM	f_{sw}	-	-	20	kHz
Arm shoot through blocking time for IPM's input signal	t_{dead}	1.0	-	-	μs
Screw Torque (M4)	-	1.3	-	1.7	Nm

■ Block Diagram

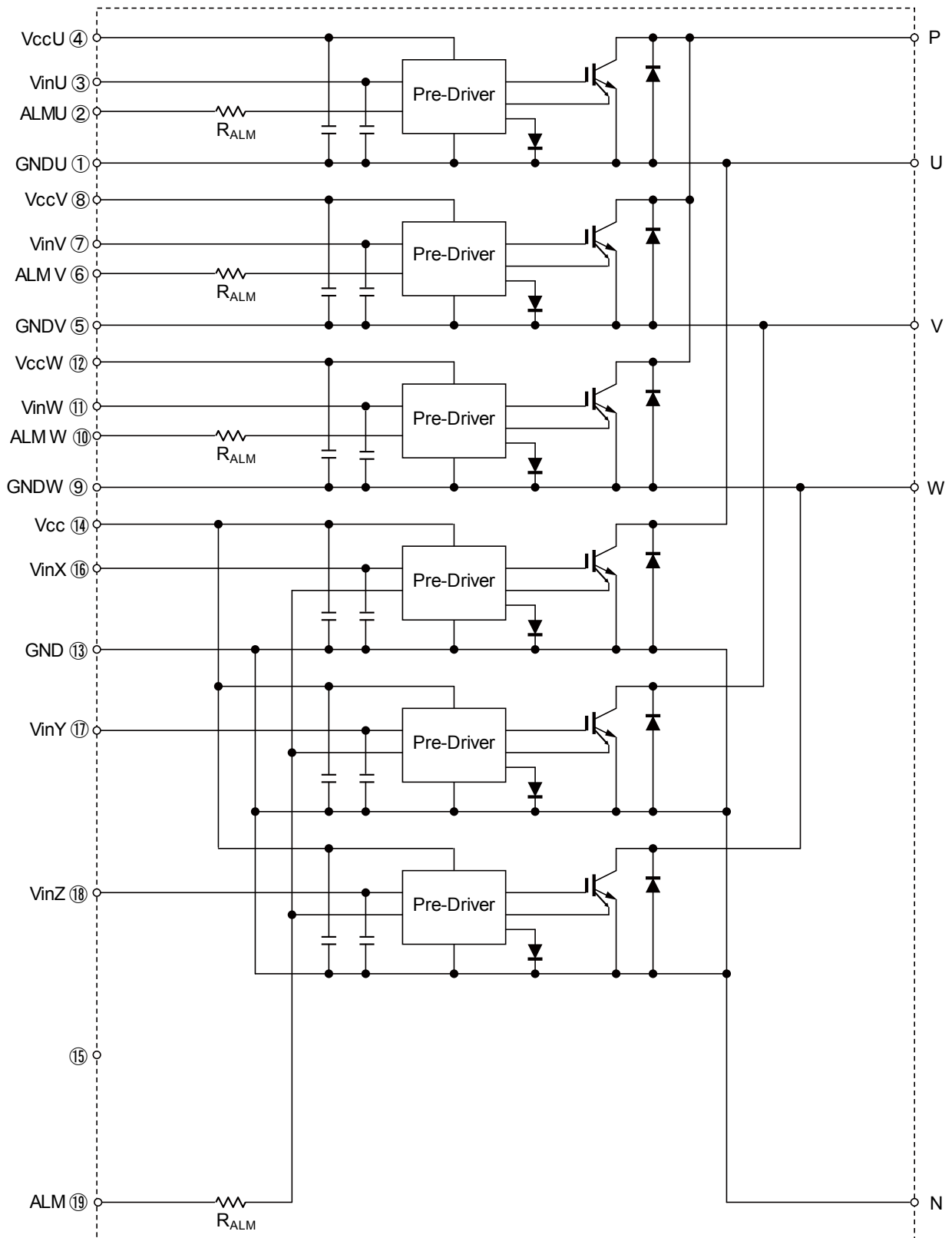

Pre-drivers include following functions

1. Amplifier for driver
2. Short circuit protection
3. Under voltage lockout circuit
4. Over current protection
5. IGBT chip over heating protection

■ Characteristics (Representative)

Power supply current vs. Switching frequency
 $T_j = 25^\circ\text{C}(\text{typ.})$

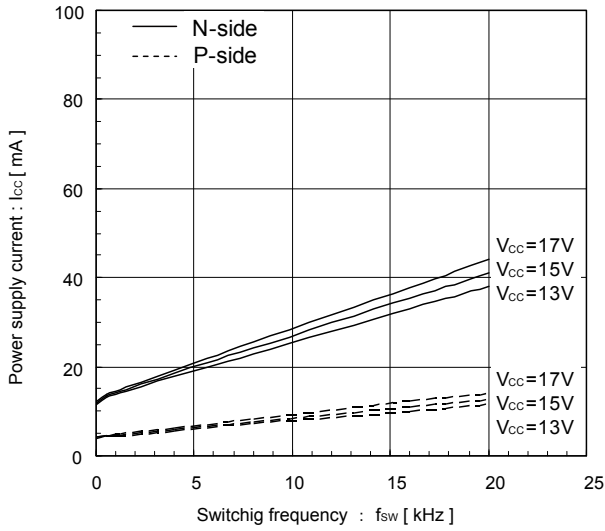

Input signal threshold voltage vs. Power supply voltage (typ.)

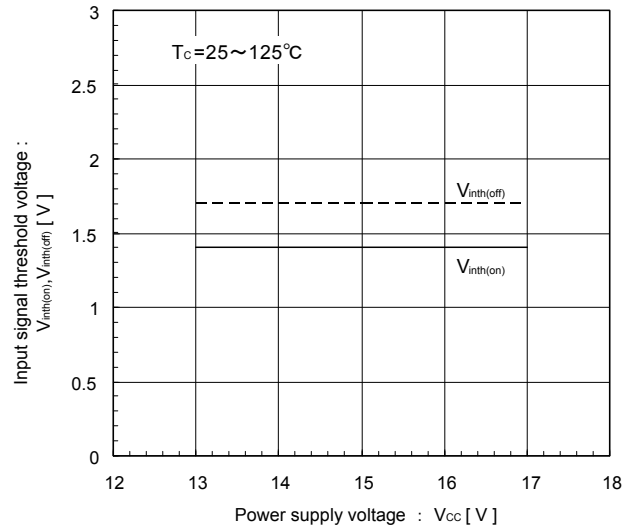

Under voltage vs. Junction temperature (typ.)

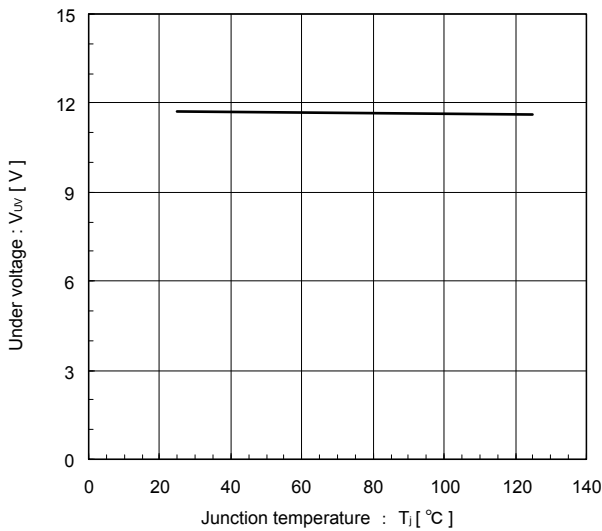

Under voltage hysteresis vs. Junction temperature (typ.)

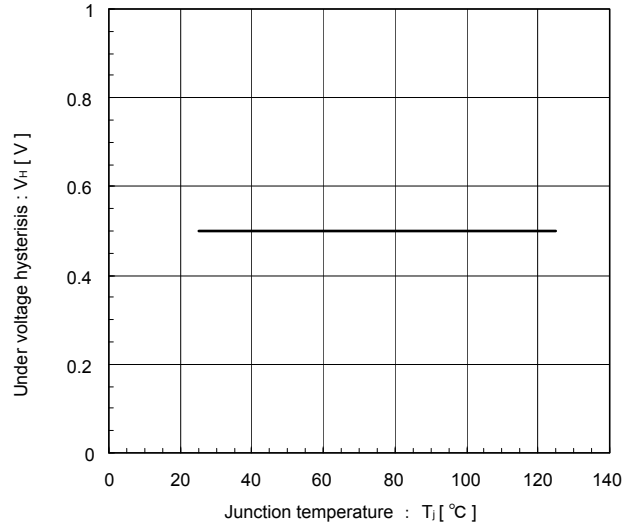

Alarm hold time vs. Power supply voltage (typ.)

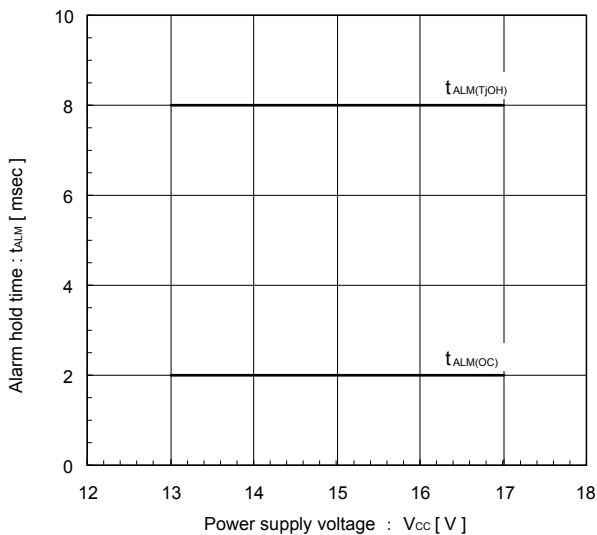

Over heating characteristics
 T_{jOH}, T_{jH} vs. V_{cc} (typ.)

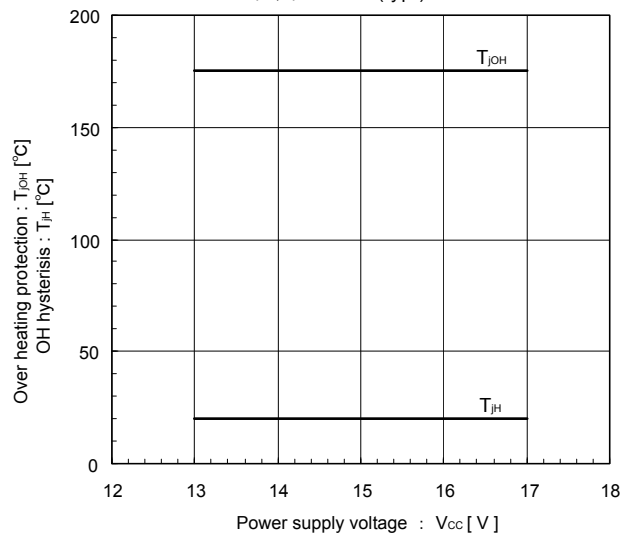

Inverter

Collector current vs. Collector-Emitter voltage
 $T_j=25^\circ\text{C}$ [Chip] (typ.)

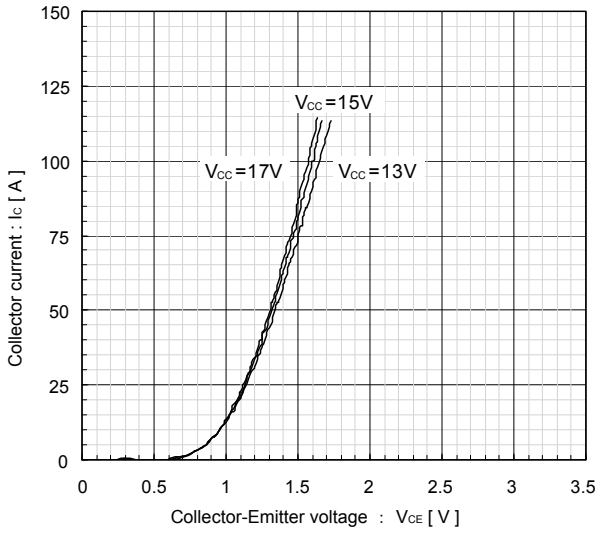

Collector current vs. Collector-Emitter voltage
 $T_j=25^\circ\text{C}$ [Terminal] (typ.)

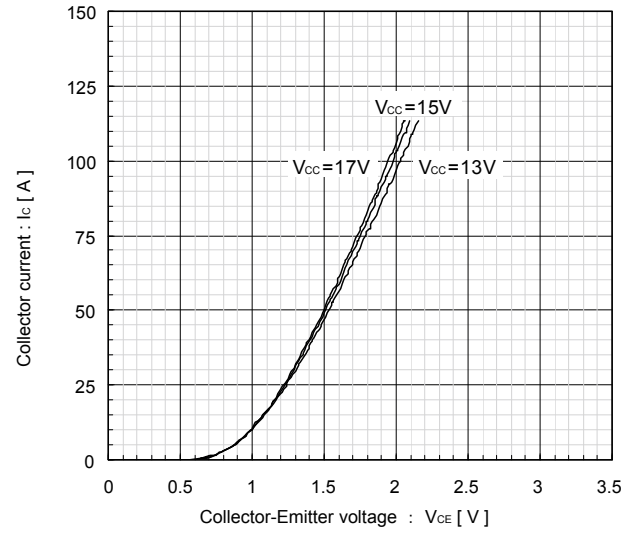

Collector current vs. Collector-Emitter voltage
 $T_j=125^\circ\text{C}$ [Chip] (typ.)

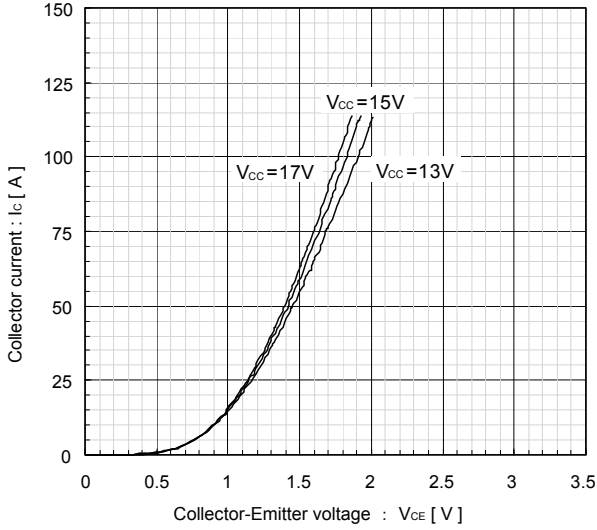

Collector current vs. Collector-Emitter voltage
 $T_j=125^\circ\text{C}$ [Terminal] (typ.)

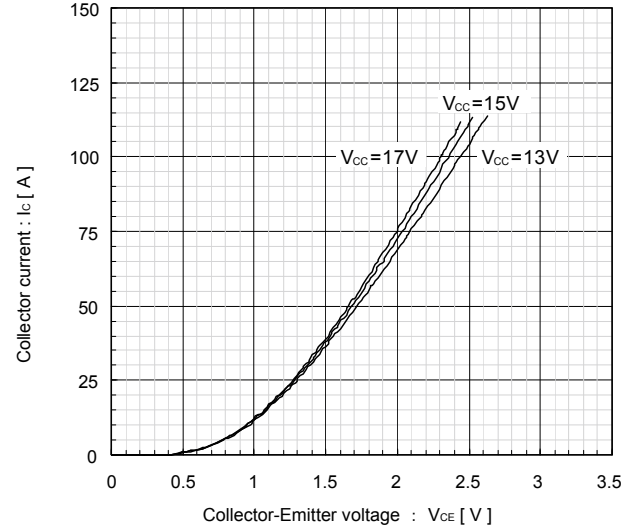

Forward current vs. Forward voltage
 [Chip] (typ.)

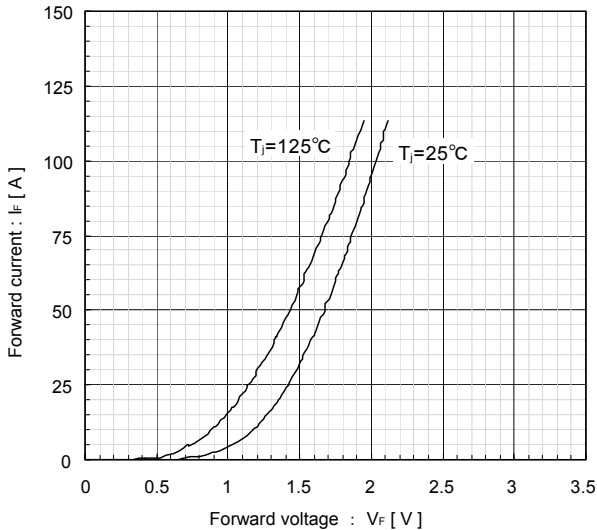

Forward current vs. Forward voltage
 [Terminal] (typ.)

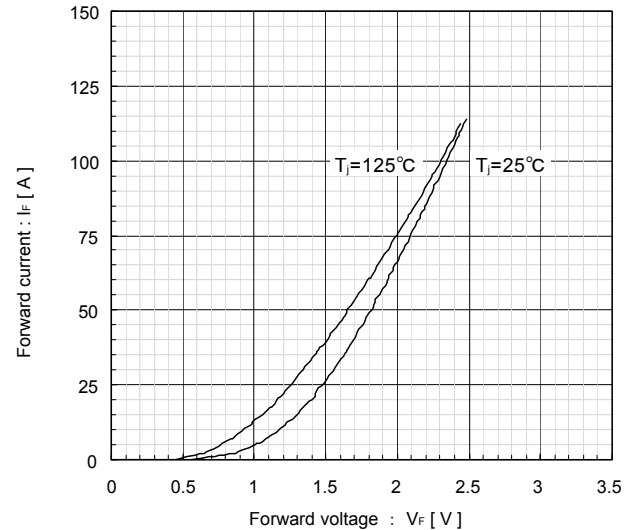

Switching Loss vs. Collector Current (typ.)
 $V_{DC}=300V, V_{CC}=15V, T_J=25^\circ C$

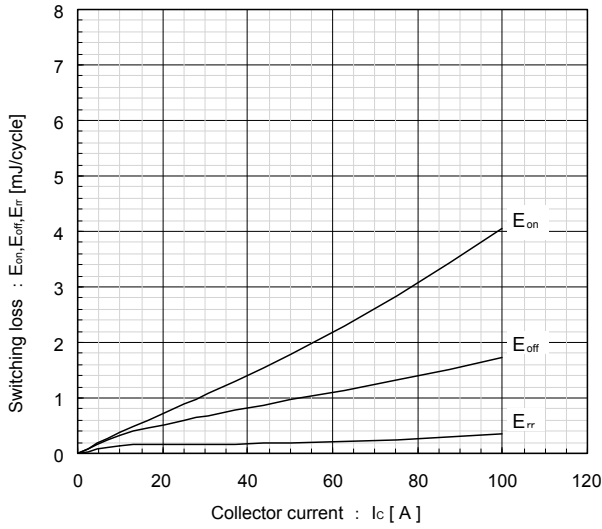

Switching Loss vs. Collector Current (typ.)
 $V_{DC}=300V, V_{CC}=15V, T_J=125^\circ C$

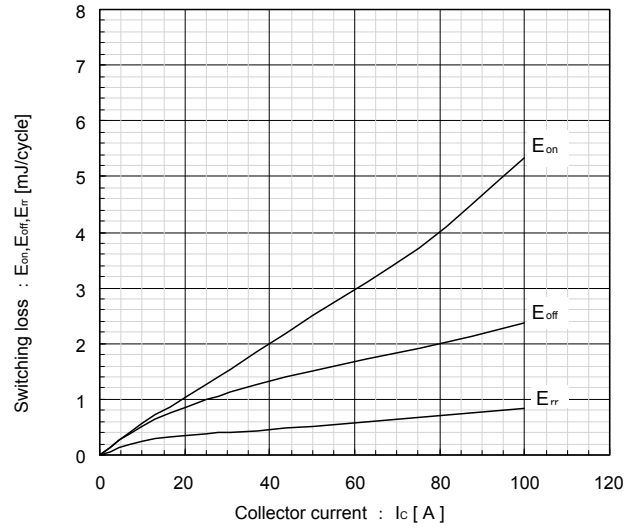

Reversed biased safe operating area
 $V_{CC}=15V, T_J \le 125^\circ C$ [Main Terminal] (min.)

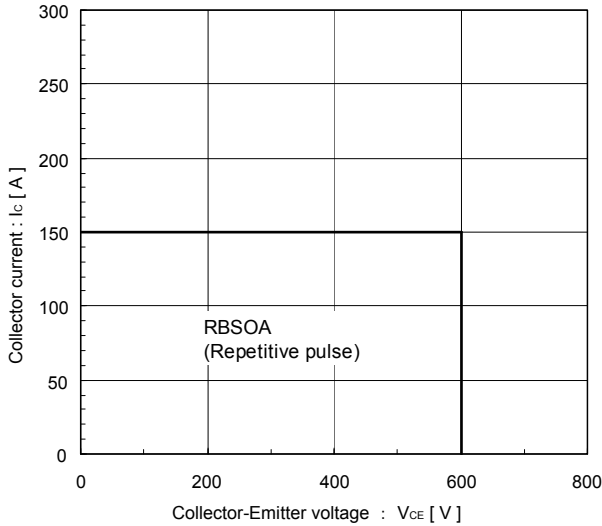

Transient thermal resistance (max.)

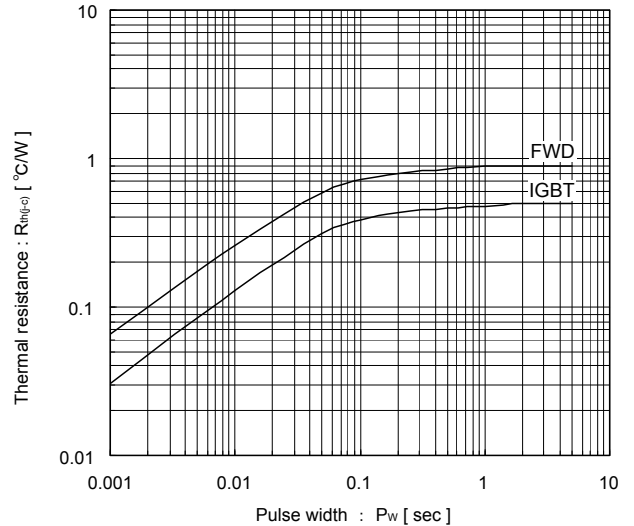

Power derating for IGBT (max.)
 [per device]

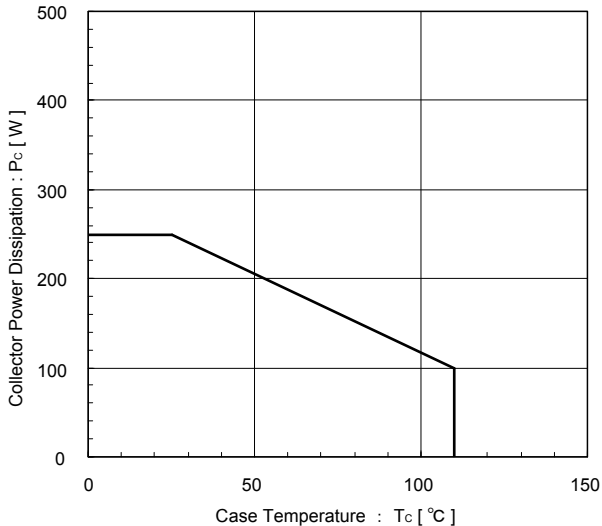

Power derating for FWD (max.)
 [per device]

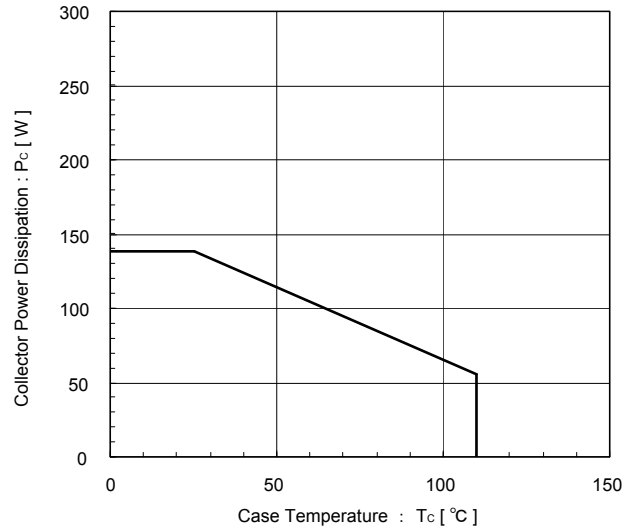

WARNING

1. This Catalog contains the product specifications, characteristics, data, materials, and structures as of May 2011. The contents are subject to change without notice for specification changes or other reasons. When using a product listed in this Catalog, be sure to obtain the latest specifications.
2. All applications described in this Catalog exemplify the use of Fuji's products for your reference only. No right or license, either express or implied, under any patent, copyright, trade secret or other intellectual property right owned by Fuji Electric Co., Ltd. is (or shall be deemed) granted. Fuji Electric Co., Ltd. makes no representation or warranty, whether express or implied, relating to the infringement or alleged infringement of other's intellectual property rights which may arise from the use of the applications described herein.
3. Although Fuji Electric Co., Ltd. is enhancing product quality and reliability, a small percentage of semiconductor products may become faulty. When using Fuji Electric semiconductor products in your equipment, you are requested to take adequate safety measures to prevent the equipment from causing a physical injury, fire, or other problem if any of the products become faulty. It is recommended to make your design failsafe, flame retardant, and free of malfunction.
4. The products introduced in this Catalog are intended for use in the following electronic and electrical equipment which has normal reliability requirements.
 - Computers
 - OA equipment
 - Communications equipment (terminal devices)
 - Measurement equipment
 - Machine tools
 - Audiovisual equipment
 - Electrical home appliances
 - Personal equipment
 - Industrial robots etc.
5. If you need to use a product in this Catalog for equipment requiring higher reliability than normal, such as for the equipment listed below, it is imperative to contact Fuji Electric Co., Ltd. to obtain prior approval. When using these products for such equipment, take adequate measures such as a backup system to prevent the equipment from malfunctioning even if a Fuji's product incorporated in the equipment becomes faulty.
 - Transportation equipment (mounted on cars and ships)
 - Trunk communications equipment
 - Traffic-signal control equipment
 - Gas leakage detectors with an auto-shut-off feature
 - Emergency equipment for responding to disasters and anti-burglary devices
 - Safety devices
 - Medical equipment
6. Do not use products in this Catalog for the equipment requiring strict reliability such as the following and equivalents to strategic equipment (without limitation).
 - Space equipment
 - Aeronautic equipment
 - Nuclear control equipment
 - Submarine repeater equipment
7. Copyright ©1996-2011 by Fuji Electric Co., Ltd. All rights reserved.
No part of this Catalog may be reproduced in any form or by any means without the express permission of Fuji Electric Co., Ltd.
8. If you have any question about any portion in this Catalog, ask Fuji Electric Co., Ltd. or its sales agents before using the product. Neither Fuji Electric Co., Ltd. nor its agents shall be liable for any injury caused by any use of the products not in accordance with instructions set forth herein.